



# **Aras Innovator 2024 Release**

## **Graph Navigation User Guide**

*Document #: D-008110*

*Last Modified: 5/20/2024*

# Copyright Information

Copyright © 2024 Aras Corporation. All Rights Reserved.

Aras Corporation  
100 Brickstone Square  
Suite 100  
Andover, MA 01810  
**Phone:** 978-691-8900

**E-mail:** [support@aras.com](mailto:support@aras.com)

**Website:** <https://www.aras.com/>

## Notice of Rights

Copyright © 2024 by Aras Corporation and/or its affiliates. All rights reserved.

This document is protected by U.S. and international copyright laws and conventions. No copyright may be obscured or removed from this document. This document may not be modified or altered, or reproduced or transmitted in any form, without the explicit permission of the copyright holder.

Aras Innovator, Aras, and the Aras Corp "A" logo are registered trademarks of Aras Corporation in the United States and other countries.

All other trademarks referenced herein are the property of their respective owners.

## Notice of Liability

THIS DOCUMENT IS PROVIDED FOR INFORMATIONAL PURPOSES ONLY, AND THE CONTENTS HEREOF ARE SUBJECT TO CHANGE WITHOUT NOTICE. THE INFORMATION CONTAINED IN THIS DOCUMENT IS DISTRIBUTED ON AN "AS IS" BASIS, WITHOUT WARRANTY OF ANY KIND, EXPRESS OR IMPLIED, INCLUDING, BUT NOT LIMITED TO, THE IMPLIED WARRANTIES OF MERCHANTABILITY AND FITNESS FOR A PARTICULAR PURPOSE OR A WARRANTY OF NON-INFRINGEMENT. ARAS SHALL HAVE NO LIABILITY TO ANY PERSON OR ENTITY WITH RESPECT TO ANY LOSS OR DAMAGE CAUSED OR ALLEGED TO BE CAUSED DIRECTLY OR INDIRECTLY BY THE INFORMATION CONTAINED IN THIS DOCUMENT OR BY THE SOFTWARE OR HARDWARE PRODUCTS DESCRIBED HEREIN.

# Table of Contents

Overview .....	4
<b>1</b> <b>Opening a Graph View .....</b>	<b>5</b>
<b>2</b> <b>Interacting with a Graph View .....</b>	<b>6</b>
2.1    Graph View Selector .....	6
2.2    Layout Selector .....	6
2.3    Center on Context Item .....	6
2.4    Fit All .....	6
2.5    Pan and Zoom.....	7
2.6    Expand and Collapse .....	7
2.6.1 <i>Expand</i> .....	7
2.6.2 <i>Collapse</i> .....	8
2.6.3 <i>Selective Expand and Collapse</i> .....	8
2.7    Context Menu Options .....	9
2.7.1 <i>Open Item</i> .....	9
2.7.2 <i>Open Item Graph View</i> .....	9
2.7.3 <i>Center Node in Graph View</i> .....	9

# Overview

The Graph Navigation application provides a means to visualize and explore complex data structures. Administrators configure and customize graph views for enabled ItemTypes. Users can open a Graph View and quickly find related items by expanding the underlying data and opening item forms for selected nodes in new tabs. This guide explains the built-in, interactive features of Graphs and how an end user can leverage these tools.

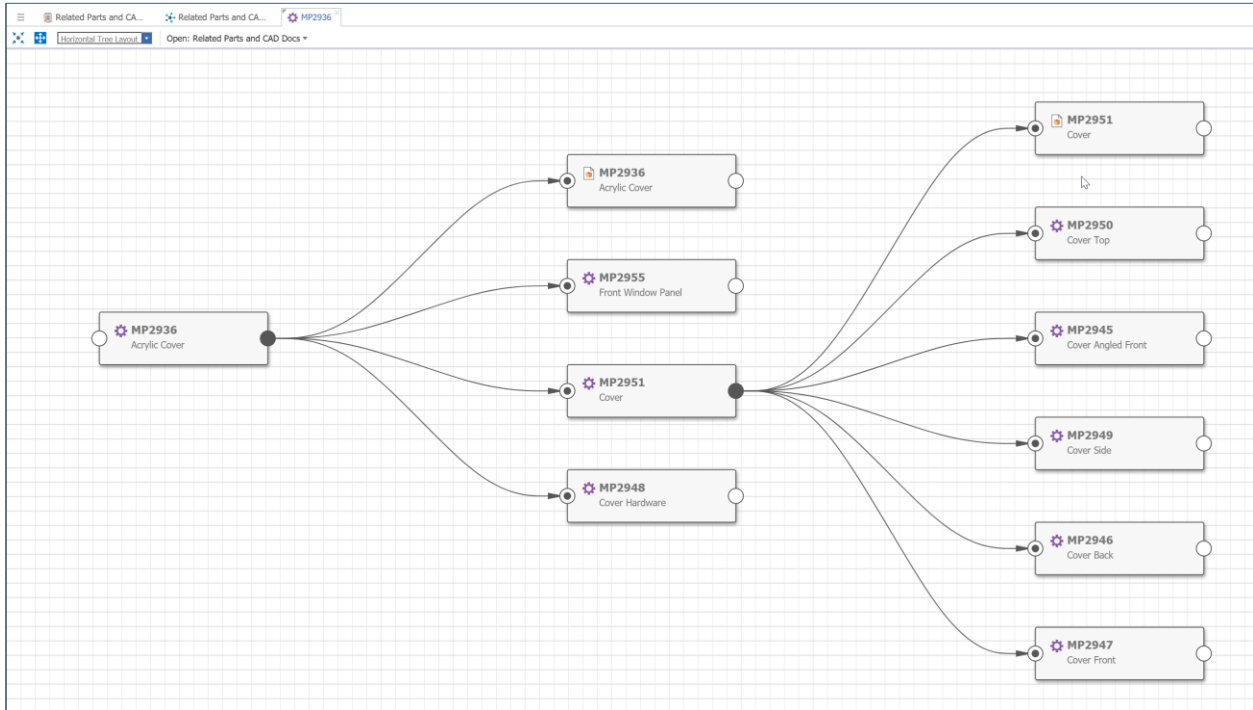

Figure 1.

# 1 Opening a Graph View

---

Graph Views can be configured to display either within the relationship tab of an item or in a separate tab by calling the **Show Graph** action on an enabled Item type. Configuration instructions are found in the *Aras Innovator 2024 Release - Graph Navigation Administrator Guide*.

**Note:** The way the graph view is opened may vary greatly depending on how it is configured by an Administrator.

## 2 Interacting with a Graph View

Once you open a Graph View, there are a number of interaction tools and actions available to use within the Graph View Toolbar. These are described in the following sections.

### 2.1 Graph View Selector

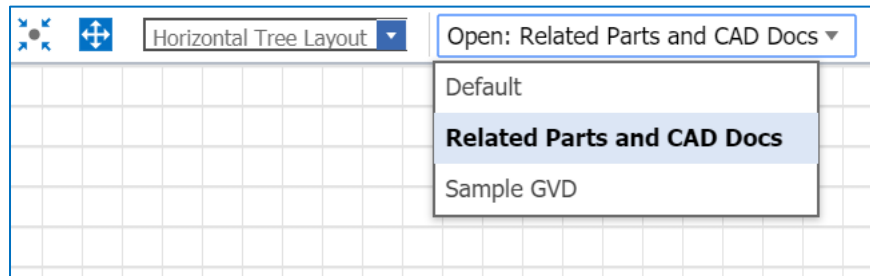

Figure 2.

Select a Graph View to display from the list of enabled Graph Views for the Context Item. This list is specific to the user and is based on the context ItemType and user permissions to the GVDs in the system.

### 2.2 Layout Selector

Select a layout from the **Graph Layout** dropdown . Available layouts are:

- **Horizontal Tree Layout** – A horizontal tree layout is populated from left to right, as shown in Figure 1.
- **Vertical Tree Layout** – A vertical tree layout is populated from top to bottom.
- **Force Layout** – A force-directed layout is populated from the context item outward in all directions such that interconnected nodes are grouped together.

### 2.3 Center on Context Item

Click the **Center on Context Item** Icon  to bring the context item to the center of the view. Note that the zoom level will not change when you click the icon.

### 2.4 Fit All

Click the **Fit All** Icon  to bring all expanded content into the view. This changes the zoom level and centers the content so all nodes and connectors are visible without the need to scroll.

## 2.5 Pan and Zoom

Use the mouse wheel to zoom in and out of a Graph View. To pan around the Graph View, press and hold the left mouse button and move the mouse. Alternatively, use scrollbars to pan around the Graph View.

## 2.6 Expand and Collapse

The expand/collapse button displayed on each node indicates the state of the node. Possible states are:

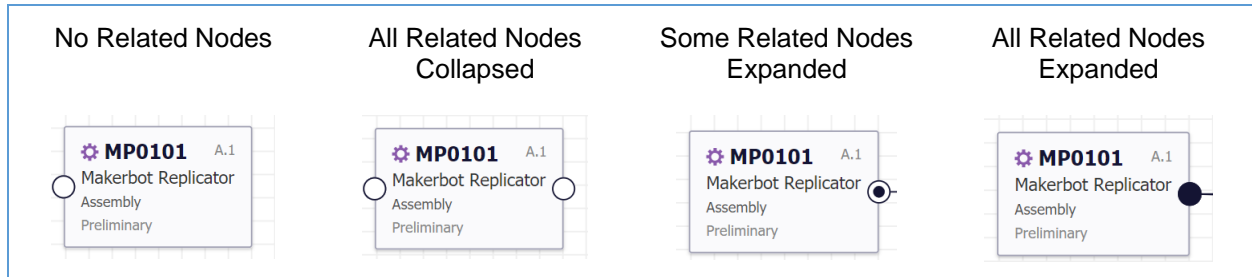

Figure 3.

### 2.6.1 Expand

To expand all outgoing connectors from a node, click on the expand/collapse button. You can also right-click on a node to bring up the context menu and select **Expand**. To control which relationships are being expanded, use Selective Expand (Section [2.6.3](#))

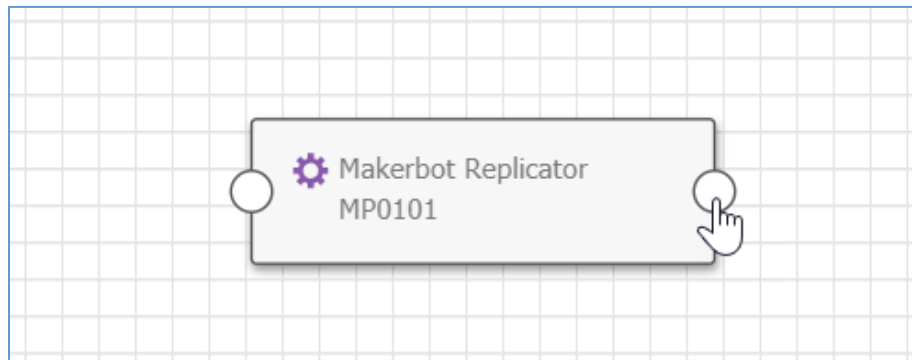

Figure 4.

## 2.6.2 Collapse

You can either click the Expand/Collapse button to collapse all outgoing connectors from a node, or you can right-click on a node and select **Collapse** from the context menu. Use Selective Collapse to control which relationships are being expanded. (Section [2.6.3](#)).

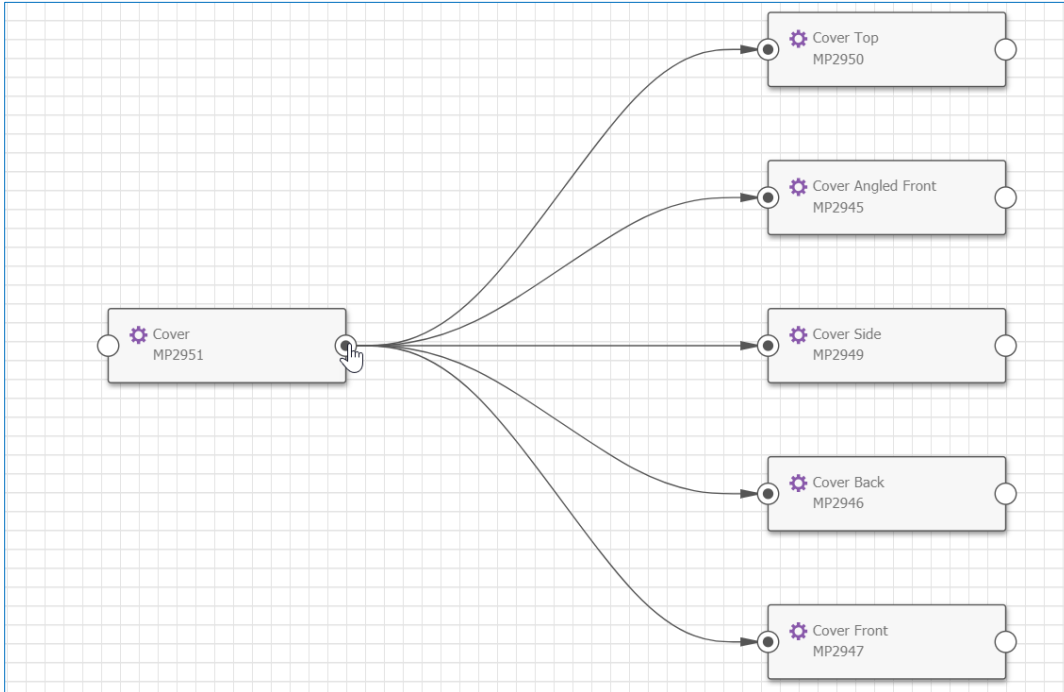

Figure 5.

## 2.6.3 Selective Expand and Collapse

You can choose to selectively expand or collapse specific relationships and properties. Right click on the expand/collapse button to bring up the selection menu. In the selection menu, use the checkboxes to filter the expansion and then click **apply** to expand or collapse the selections.

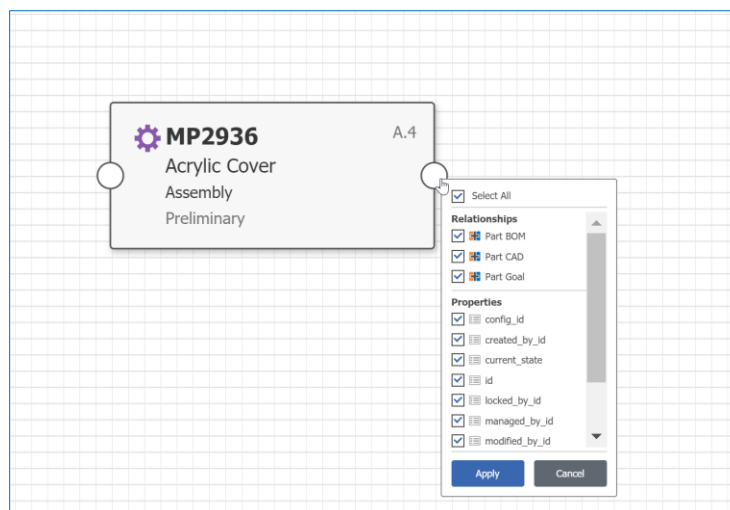

Figure 6.



## 2.7 Context Menu Options

Right click within the Graph View to access the context menu.

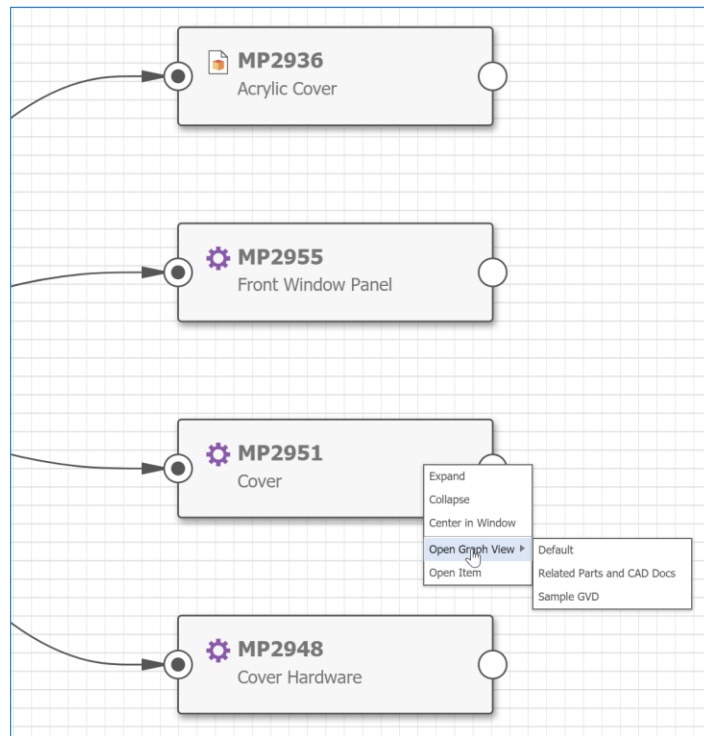

Figure 7.

### 2.7.1 Open Item

To open an item visible in a Graph View, right-click on a node to access the context menu and then select **Open Item**. The Item form opens in a new tab.

### 2.7.2 Open Item Graph View

To open a Graph View with a specific node as the new context item, right-click on a node to pull up a context menu and then select an available Graph View from the **Open Graph View** fly-out menu. The new Graph View will then be opened in a new tab. The **Open Graph View** option will only be available when valid Graph Views are available for the context item.

### 2.7.3 Center Node in Graph View

To center the Graph View on a specific node, right click on a node and then select **Center in Window**. The selected node will then appear in the center of the view. Note that the zoom level will not change when this action is performed.